

Sonderausführungen – Masse

EB.S450H – mit 3 Hahnlöchern

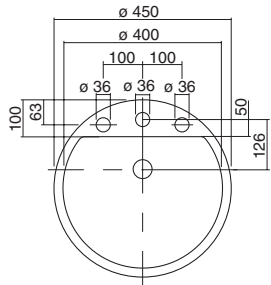

EB.S450H – mit Lotionspenderbohrung

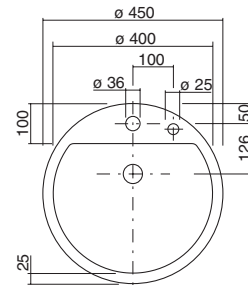
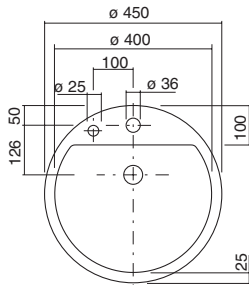

EB.K450H – mit 3 Hahnlöchern

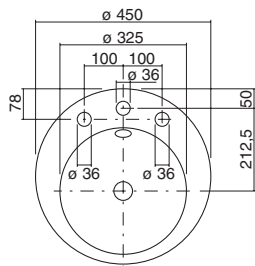

EB.K450H – mit Lotionspenderbohrung

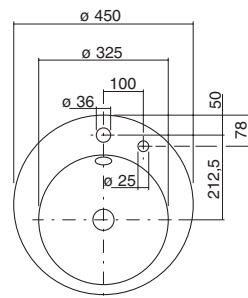
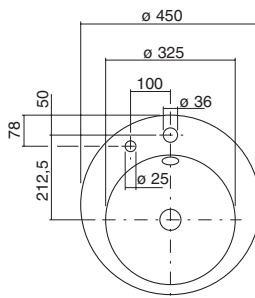

EB.0600H – mit 3 Hahnlöchern

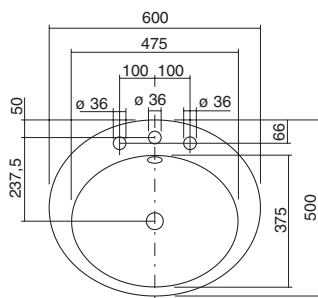

EB.0600H – mit Lotionspenderbohrung

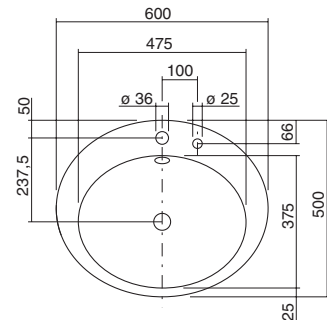
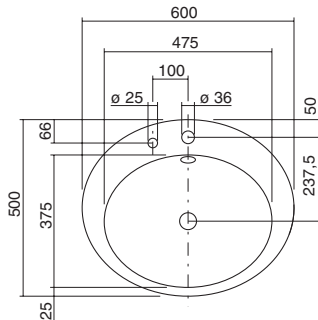

EB.0500H – mit 3 Hahnlöchern

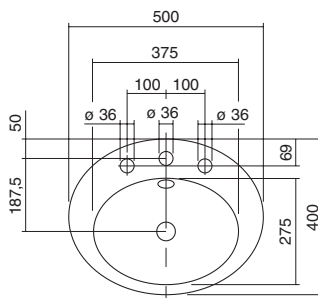

EB.0500H – mit Lotionspenderbohrung

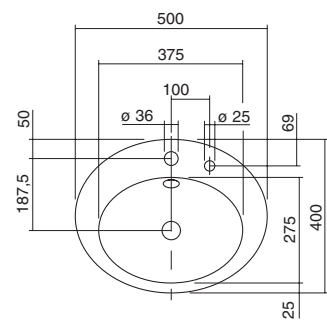
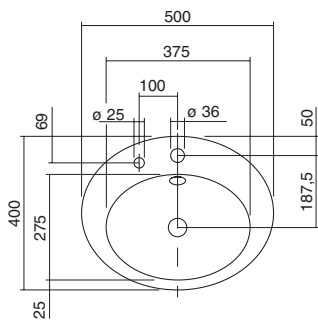

EB.R585H – mit 3 Hahnlöchern

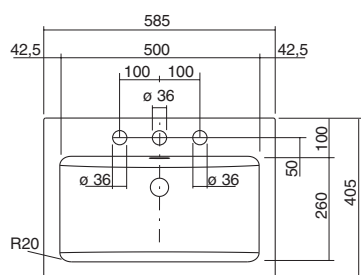

EB.R585H – mit Lotionspenderbohrung

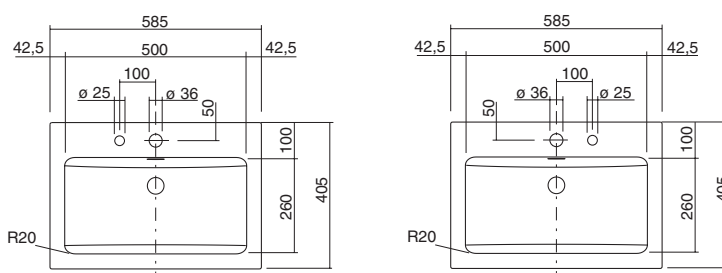

HB.R585H – mit 3 Hahnlöchern

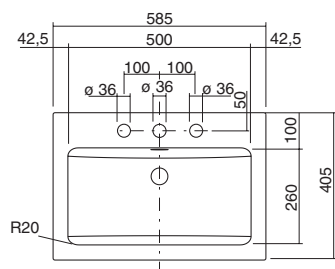

HB.R585H – mit Lotionspenderbohrung

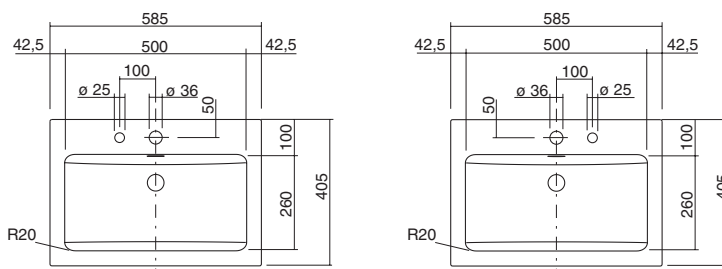

HB.S450H – mit Lotionspenderbohrung

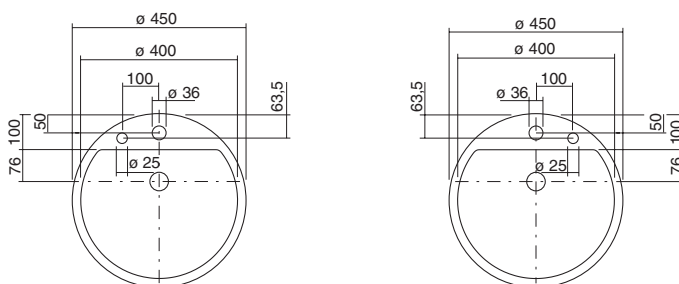

Sonderausführungen – Masse

WT.PR585H3 – mit 3 Hahnlöchern

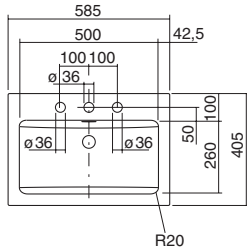

WT.PR585H – mit Lotionspenderbohrung

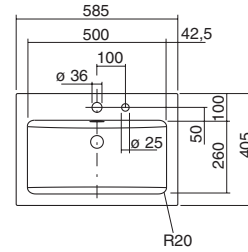
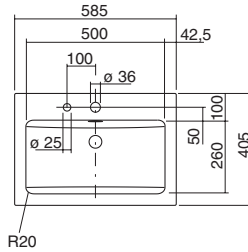

WT.PR800H3 – mit 3 Hahnlöchern

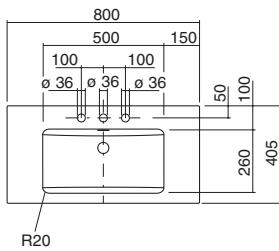

WT.PR800H – mit Lotionspenderbohrung

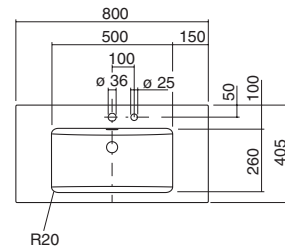
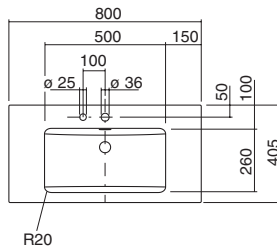

WT.PR800H3.L – mit 3 Hahnlöchern

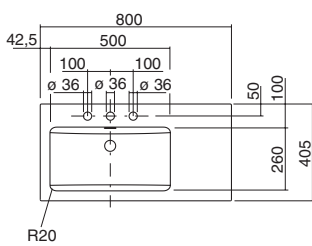

WT.PR800H.L – mit Lotionspenderbohrung

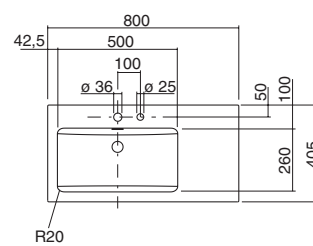
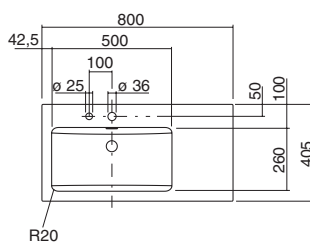

WT.PR800H3.R – mit 3 Hahnlöchern

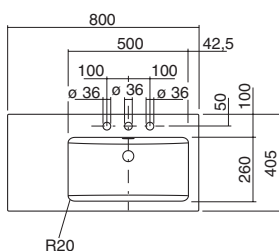

WT.PR800H.R – mit Lotionspenderbohrung

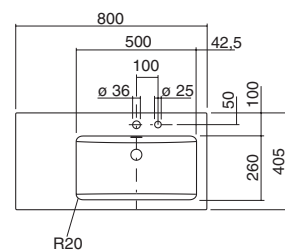
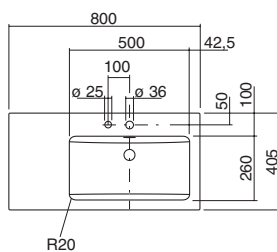

WT.PR1000H3 – mit 3 Hahnlöchern

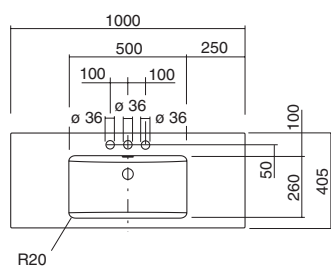

WT.PR1000H – mit Lotionspenderbohrung

