

Kombinationsbeispiel 1

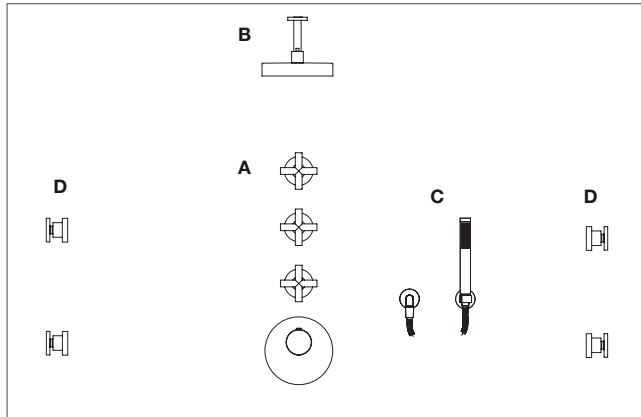

Regeleinheit

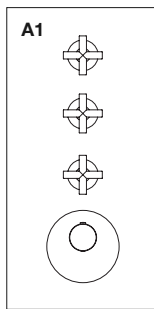

A1	1x	36 416 979-FF
	3x	36 310 892-FF
	1x	35 546 970 90

Kombinationsbeispiel 2

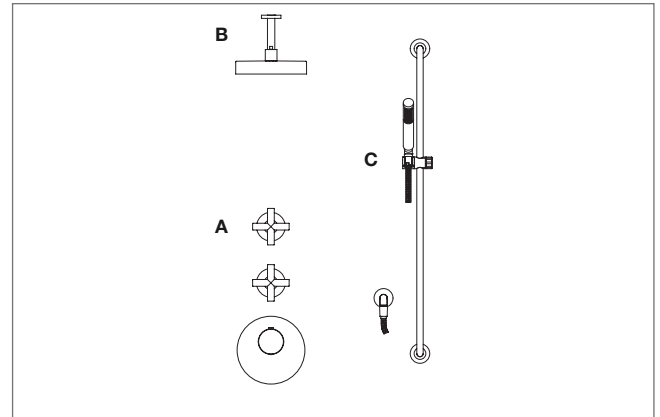

Regeleinheit

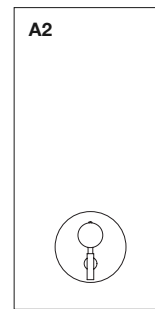
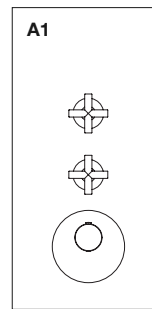

A1	1x	36 416 979-FF
	2x	36 310 892-FF
	1x	35 526 970 90

A2	1x	36 115 885-FF
	1x	35 115 970 90

Kopfbrause

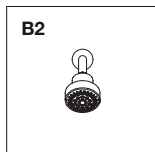
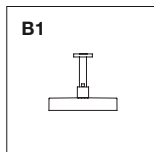

B1	1x	28 568 970-FF
B2	1x	28 508 979-FF
B3	1x	28 548 970-FF
	1x	12 556 970-FF*
B4	1x	28 558 970-FF
	1x	12 556 970-FF*

Kopfbrause

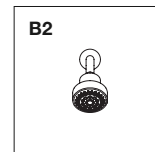
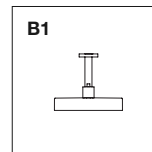

B1	1x	28 568 970-FF
B2	1x	28 508 979-FF
B3	1x	28 548 970-FF
	1x	12 556 970-FF*
B4	1x	28 558 970-FF
	1x	12 556 970-FF*

Handbrause

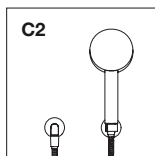
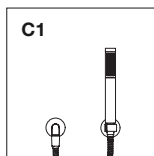

C1	1x	27 802 892-FF
C2	1x	27 803 892-FF
C3	1x	26 402 892-FF
	1x	28 450 892-FF
C4	1x	26 403 892-FF
	1x	28 450 892-FF

Handbrause

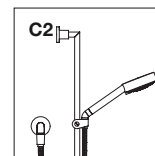
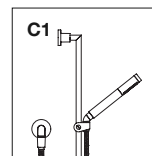

C1	1x	26 402 892-FF
	1x	28 450 892-FF
C2	1x	26 403 892-FF
	1x	28 450 892-FF
C3	1x	27 802 892-FF
C4	1x	27 803 892-FF

Seitenbrausen

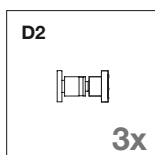
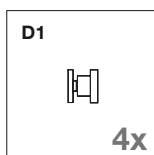

D1	4x	28 518 979-FF
D2	3x	28 519 979-FF



Tara.

Kombinationsbeispiel 3

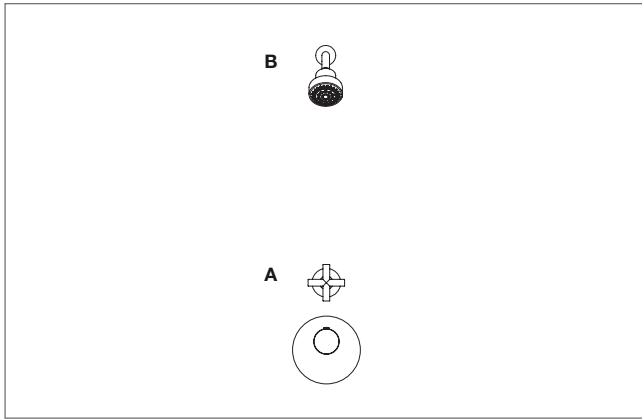

Regeleinheit

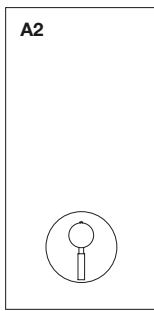
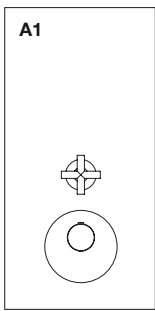

A1	1x	36 416 979-FF
	1x	36 310 892-FF
	1x	35 436 970 90
A2	1x	36 015 885-FF
	1x	35 115 970 90

Brause

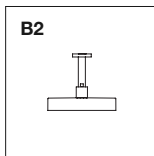
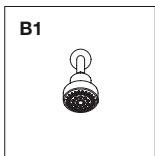

B1	1x	28 508 979-FF
	1x	28 568 970-FF
B3	1x	28 548 970-FF
	1x	12 556 970-FF*
B4	1x	28 558 970-FF
	1x	12 556 970-FF*
B5	1x	26 402 892-FF
	1x	28 450 892-FF
B6	1x	26 403 892-FF
	1x	28 450 892-FF
B7	1x	27 603 892-FF
B8	1x	26 001 892-FF

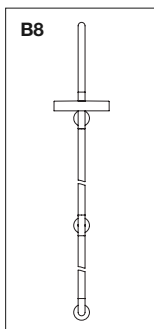
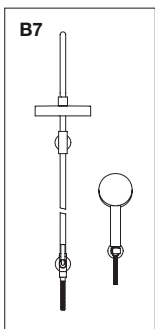
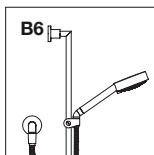
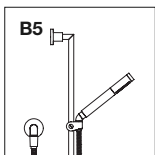
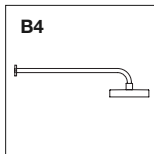
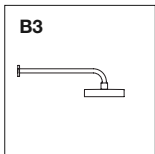

Kombinationsbeispiel 4

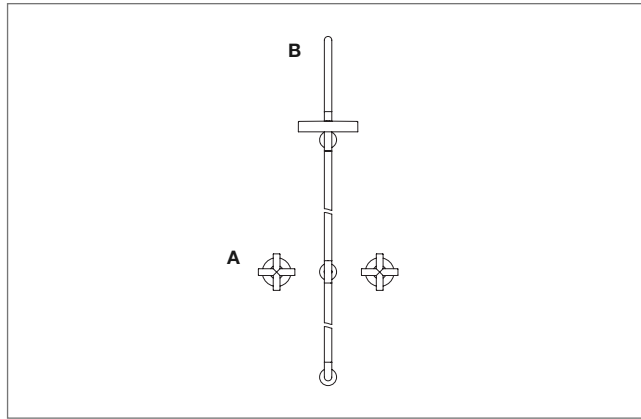

Regeleinheit

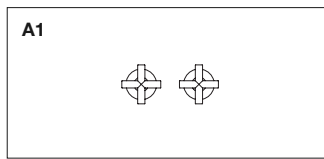

A1	2x	36 310 892-FF
	1x	35 707 970 90
A2	1x	36 416 979-FF
	1x	36 310 892-FF
	1x	35 436 970 90
A3	1x	36 015 885-FF
	1x	35 115 970 90

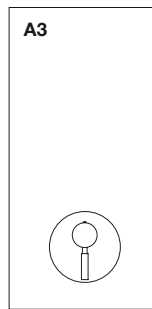
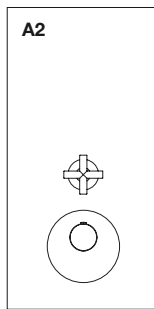

Brause

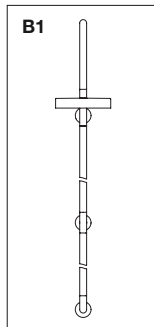

B1	1x	26 001 892-FF
-----------	----	----------------------

