

Kombinationsbeispiel 1

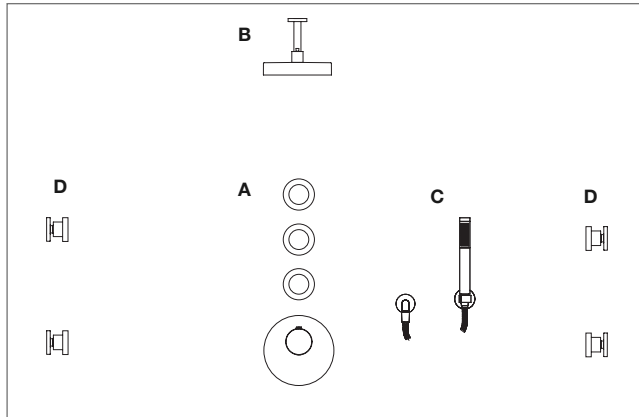

Regeleinheit

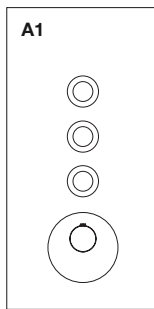

A1	1x	36 416 979-FF
	3x	36 310 979-FF
	1x	35 546 970 90

Kopfbrause

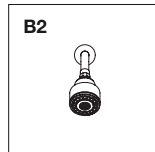
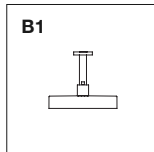

B1	1x	28 568 970-FF
B2	1x	28 508 979-FF
B3	1x	28 548 970-FF
	1x	12 556 970-FF*
B4	1x	28 558 970-FF
	1x	12 556 970-FF*

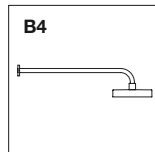
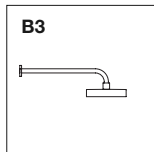

Handbrause

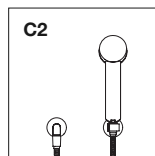
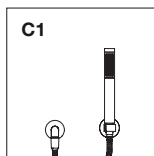

C1	1x	27 806 625-FF
	1x	28 450 625-FF
C2	1x	27 805 625-FF
	1x	28 450 625-FF
C3	1x	26 402 625-FF
	1x	28 450 625-FF
C4	1x	26 403 625-FF
	1x	28 450 625-FF

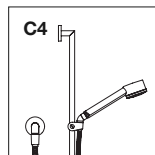
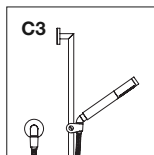

Seitenbrausen

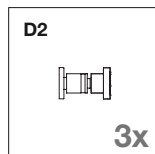
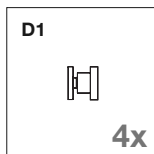

D1	4x	28 518 979-FF
D2	3x	28 519 979-FF

Kombinationsbeispiel 2

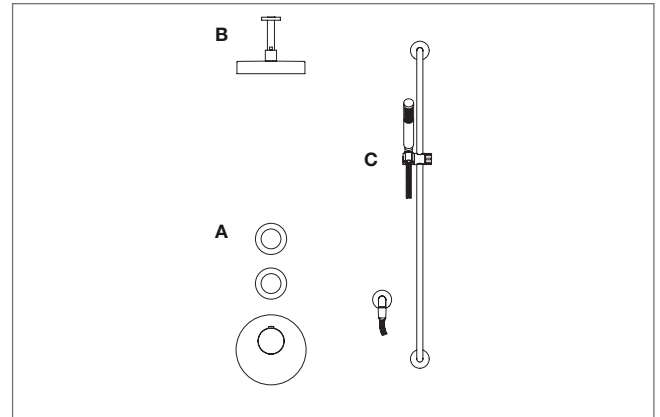

Regeleinheit

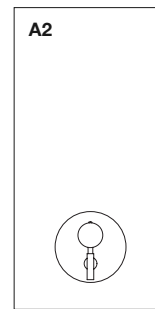
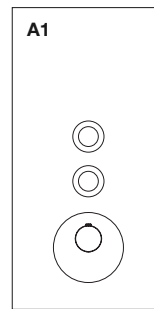

A1	1x	36 416 979-FF
	2x	36 310 979-FF
	1x	35 526 970 90
A2	1x	36 115 885-FF
	1x	35 115 970 90

Kopfbrause

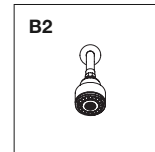
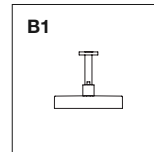

B1	1x	28 568 970-FF
B2	1x	28 508 979-FF
B3	1x	28 548 970-FF
	1x	12 556 970-FF*
B4	1x	28 558 970-FF
	1x	12 556 970-FF*

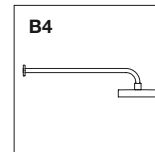
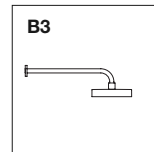

Handbrause

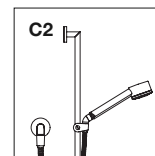
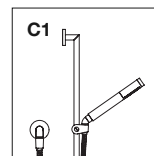

C1	1x	26 402 625-FF
	1x	28 450 625-FF
C2	1x	26 403 625-FF
	1x	28 450 625-FF
C3	1x	27 806 625-FF
	1x	28 450 625-FF
C4	1x	27 805 625-FF
	1x	28 450 625-FF

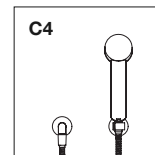
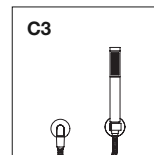

Kombinationsbeispiel 3

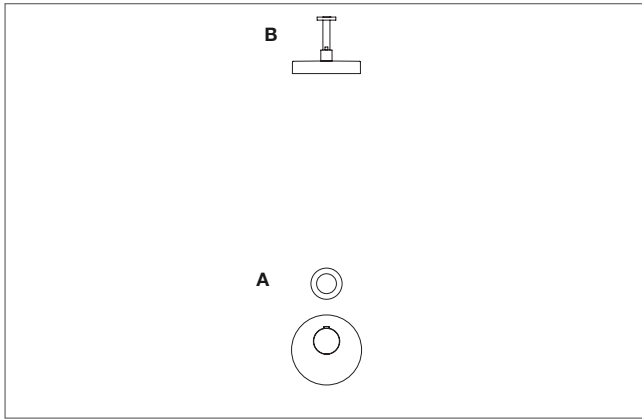

Regeleinheit

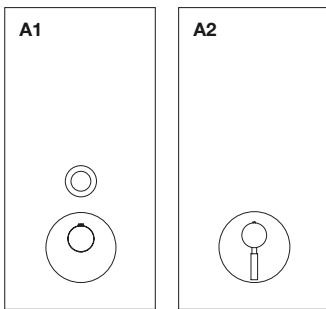

A1	1x	36 416 979-FF
	1x	36 310 979-FF
	1x	35 436 970 90
A2	1x	36 015 885-FF
	1x	35 115 970 90

Kopfbrause

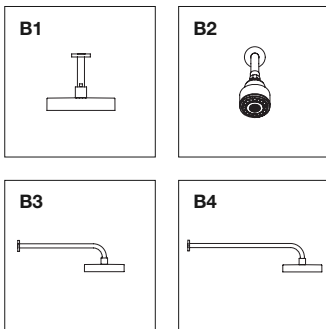

B1	1x	28 568 970-FF
	1x	28 508 979-FF
B2	1x	28 548 970-FF
	1x	12 556 970-FF*
B4	1x	28 558 970-FF
	1x	12 556 970-FF*

Kombinationsbeispiel 4

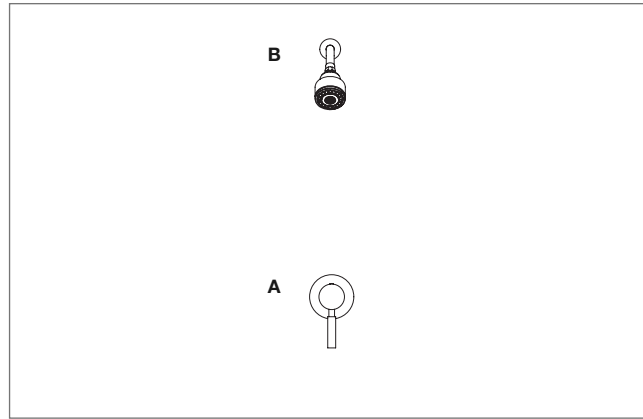

Regeleinheit

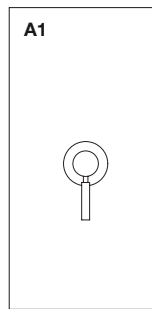

A1	1x	36 008 885-FF
	1x	35 008 970 90

Brause

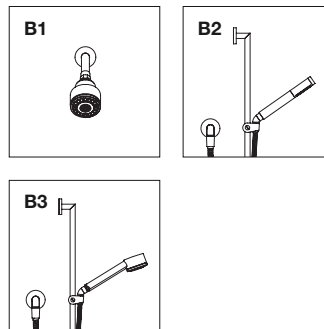

B1	1x	28 508 979-FF
	1x	26 402 625-FF
B2	1x	28 450 625-FF
	1x	26 403 625-FF
B3	1x	28 450 625-FF



TARA .LOGIC